

Installation Instructions

SLIMCLASSIC & SLIMHANDSFREE

PROFESSIONAL INSTALL ONLY

Do NOT give this manual to end user!

SLIM | CLASSIC



SLIM | HANDSFREE

Manual Version 1

The manufacturer cannot legally offer technical support to non-qualified gate or door installers. End users should employ the services of a professional install company to commission or support this product!



Tip: Site Survey BEFORE you begin.

Index

Site Survey	Pg 3
Multiple Handset Wiring Survey	Pg 3
Opening the Outdoor Station	Pg 4
Wiring	Pg 4
Mounting Handsets	Pg 5
Connecting to Gates and Locks	Pg 5
Power at Gate	Pg 6
Keypad Overview	Pg 6
Keypad Quick Start	Pg 7
Keypad Full Programming	Pg 7
Using a Standard Keypad Code	Pg 8
Using a Latching Code	Pg 8
How to Use the Intercom	Pg 9
Troubleshooting	Pg 11
Change History	Pg 12

Site Survey

Before installing this system, please check the cable type which exists and then design the installation accordingly.

The maximum distance between the outdoor and indoor units depends on the type and thickness of cable used, the number of handsets on the system and if the handsfree or classic handsets are being used (handsfree use double the power).

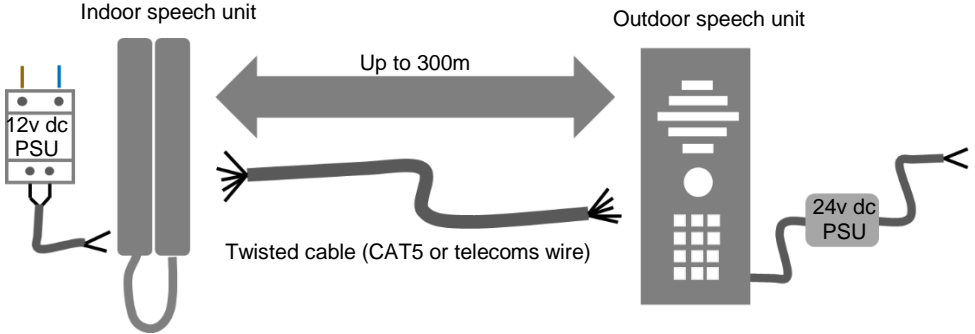

Multiple Handsets Wiring Survey

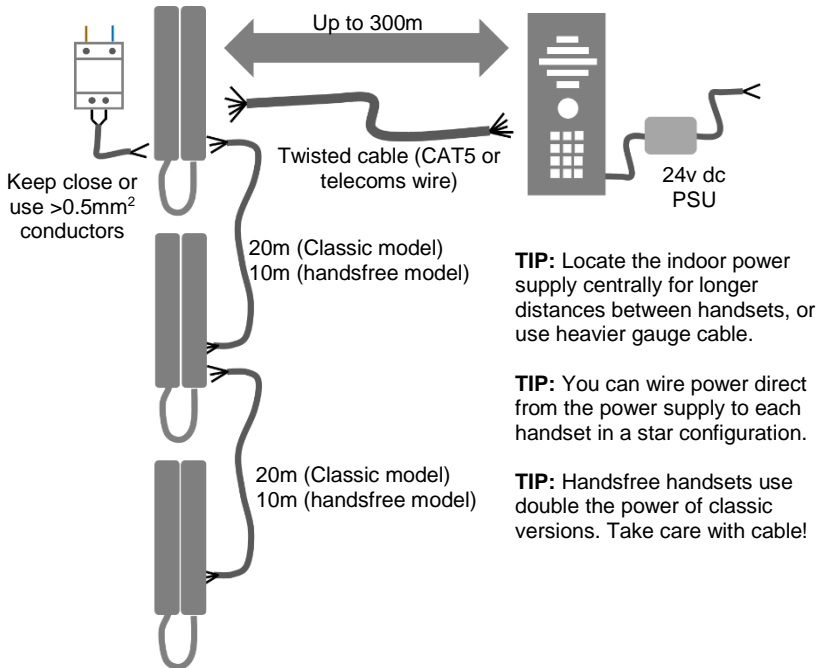

Opening the Outdoor Station

Wall mount version
Open top screws only

Flush Version
Open top and bottom screws

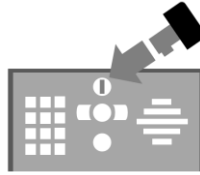

Pedestal Version
Use security key to open

Wiring

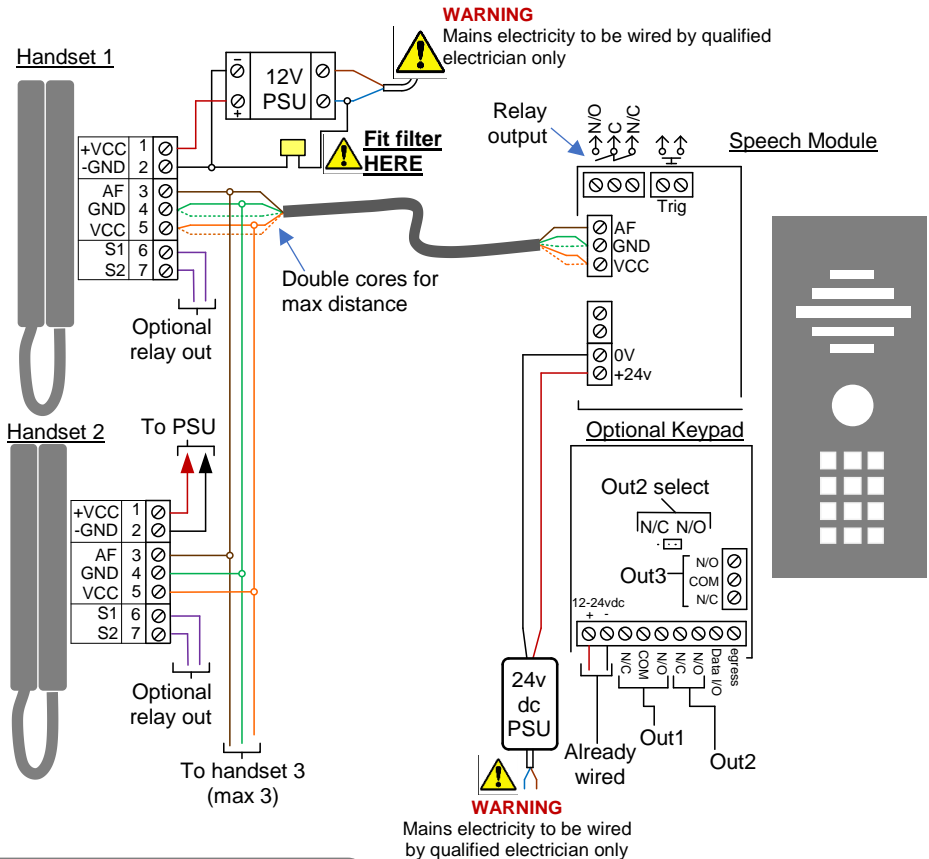

TIP:
Fit filter on 12v PSU as shown, between 0v out and Neutral.

TIP:
Keypad has independent relays from the speech module. Both need connected!!
Connect in parallel for gate automation or strike locks, and in series for magnetic lock control.

Mounting Handsets

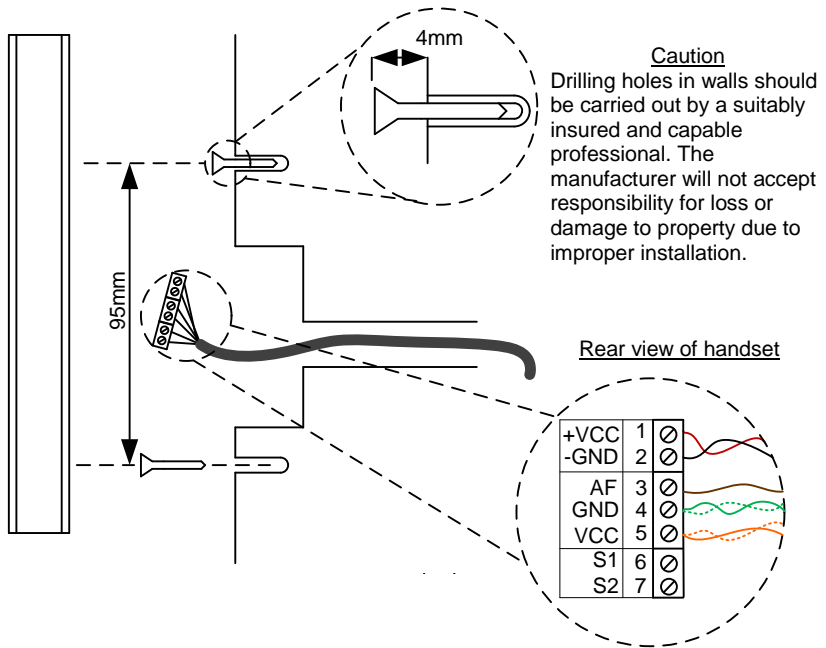

Connecting Relays to Gates & Locks

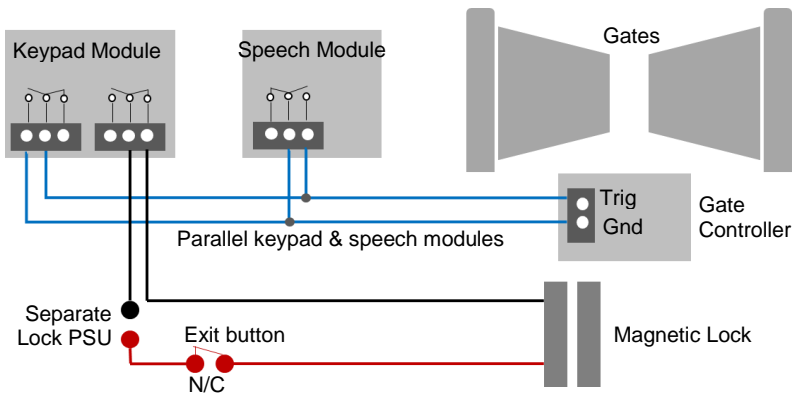

Power at Gate

This intercom comes with a 24v dc power supply for the outdoor speech unit. Relays can require up to 1 amp peak demand to trigger, therefore power cable is of significant importance. It is preferred the 24v dc PSU is installed within close proximity of the intercom. However, on occasion this may be difficult to achieve. Please adhere to the cable thickness guide below or the device may be damaged and rendered out of warranty by the manufacturer.

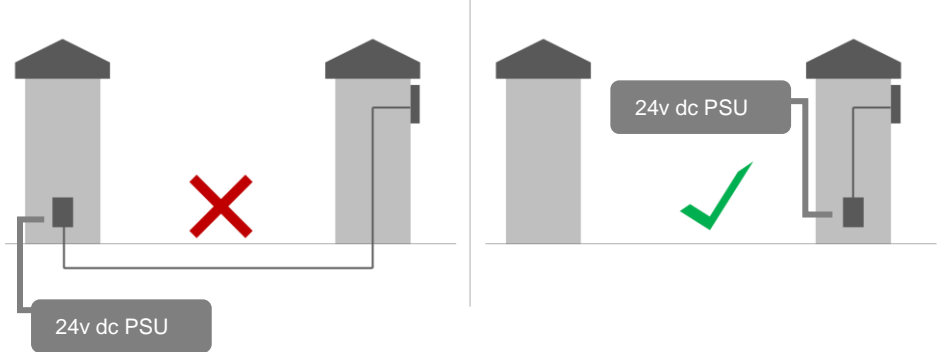

- Up to 2 meters (6 feet) use minimum 0.5mm.
- Up to 4 meters (12 feet) use minimum 0.75mm.
- Up to 8 meters (25 feet) use minimum 1.0mm.

Keypad overview

This keypad has 3 outputs, all independent from the intercom/app relays. The diagram below shows the LED indicators which indicate programming and relay status information.

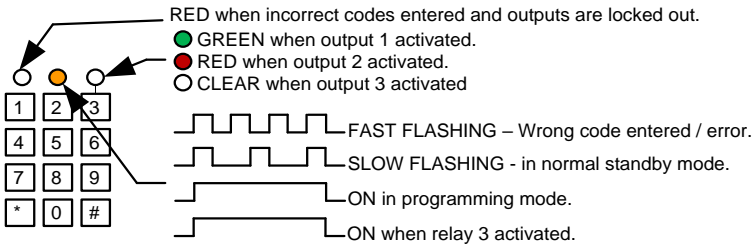

TIP: After power up, as a security precaution, the keypad cannot be programmed for 60 seconds. Once this time elapses, you may begin.

TIP: Flashing amber LED is normal standby mode!

Keypad Programming

Quick start guide

1) Enter programming mode (amber LED should be ON)

0 0 0 0 * *

2) Enter a new user code...

1 0 2 0 0 0 ? ? ? ? #

3) Exit programming mode

* *

4) Enter the new user code to check the relay clicks.

Tip: The engineer code must be the same length as user codes. If using a 6 digit engineers code, then user codes must also be 6 digits long etc.

Full Keypad programming

Enter programming mode..

0 0 0 0 * *

The unit is now in programming mode. Amber LED on the keypad should remain permanently on. 0000 is the default programming passcode.

Exit programming mode..

* *

The unit should exit programming mode and the amber LED should start flashing again.

Enter a new ENGINEER/INSTALLERS code...

Go into programming mode firstly then enter the following sequence...

0 1 ? ? ? ? #
 Location 4-8 digit code Validate

Replace ??? with your new ENGINEERS code.

Enter or delete new user/Homeowner codes

There are 3 groups of user codes. Group 10 for relay 1, group 20 for relay 2, and group 30 for relay 3. The programming sequence is shown below...

1 0 2 0 0 0 ? ? ? ? #

10= relay 1 codes (1000 available)
 20= relay 2 codes (100 available)
 30= relay 3 codes (100 available)

2= add code
 5= delete code

Memory locations
 000-999 for relay 1
 001-100 for relay 2
 001-100 for relay 3

Pin code 4-8 digits Validate

Example: Add user 31 to have access code 5555 operating relay 2....

2 0 2 0 3 1 5 5 5 5 #

Group 2 Add code Location 31 Pin code 5555 Validate

Programming relay output times and modes...

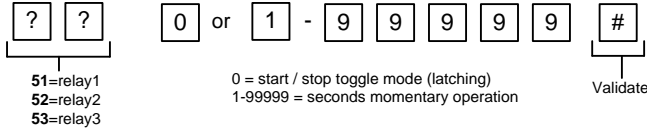

Delete a user code even if you don't know the code...

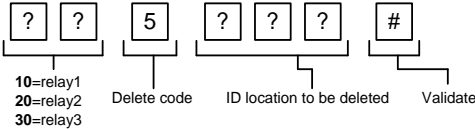

Delete an entire group of codes

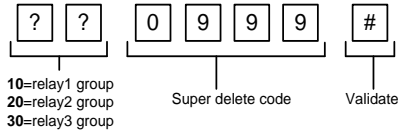

Programming super user codes...

A super user code can activate any of the 3 relays

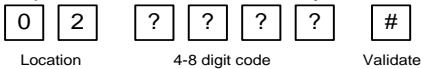

Restoring defaults

When in programming mode, you can enter the following sequence...

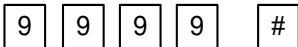

When the engineers/installers code is forgotten....

- 1) Wire a push button (or replicate with wire link) across the Egress terminal and (-)GND.
- 2) Switch off power for 1 minute.
- 3) Switch ON power.
- 4) during the first 60 seconds, press the EG button once to enable the function.
- 5) Enter the following code..



The keypad should now be in programming mode, ready to accept new data. Change the installers/engineers code now as per instructions above.

Using a Standard Keypad Code

Simply enter the code to trigger the gate or release the door.

Using a Latching Code

Enter the latching code on automatic gates to hold them open. Note: the code will need entered again to unlatch the gates.

How to Use the Intercom

SLIMCLASSIC

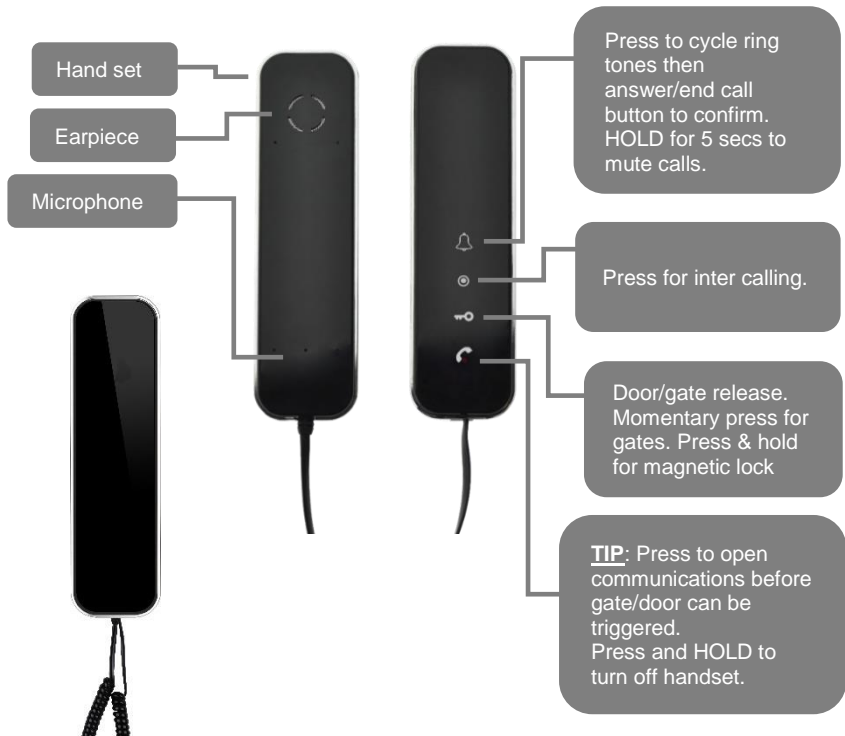

SLIMHANDSFREE



Troubleshooting

Q: The system is working but there is humming interference on the call.

A: Make sure the filter is connected on the internal power supply between the mains neutral and 0V output of the power supply as per wiring diagram.

Q: No communications from gate to handset.

A: Try communicating from another handset.

-Check the green status LED is illuminated on the speech unit at the gate.

-Check the handset has been powered on. Press and hold the power button on the handset or check for illumination from the buttons.

-Remove handset and wire to the gate station at the gate with 6 feet of cable and check if that works. If it does, then the cable may have a break or be the wrong type.

Q: First handset works, but second handset does not.

A: Swap them around, and check if the problem follows the handset or remains with the location. If it remains with the location, it is an installation problem. Check wiring, cable gauge used for power etc. If it follows the handset, call technical support. It may have a defect or be damaged.

Q: Communications work but it does not release the gates or lock.

A: Listen for a relay click when the lock release button is pressed. Even better, remove the wires to the lock or gate, use a multimeter on continuity mode, and listen for bell tone when the lock release button is pressed. If that works, then it is an installation problem. Check wiring diagram for tips. If that does not work, check the distance from the gate to the handset. It may be too far to use the outdoor speech unit relay. Try using 2 cores to connect the relay inside the handset to the gate controller instead.

Change History

Version			Reason for change
P	H	S	
1	1	1	First version.

The manufacturer cannot legally offer technical support to non-qualified gate or door installers due to insurance and safety legislation. End users should employ the services of a professional install company to commission or support this product!

